

**Connection diagram**

**1 channel**

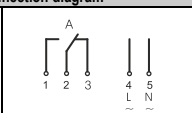

**2 channels**

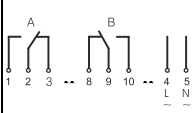

**1. Safety instructions**

- The installation and assembly of electrical equipment must be only carried out only by a skilled Person! Otherwise fire danger or danger of an electric shock exists!
- Connect the supply voltage/frequency as stated on the product label!
- Warranty void if housing opened by unauthorised person!
- The electronic circuit is protected against a wide range of external influences. Incorrect operating may occur if external influences exceed certain limits

**2. Initial operation**

- The time switch is delivered in sleep-mode, the display is switched off.
- Press **OK/M**-button to wake it up.
- The current date and time is already programmed and European daylight savings time is activated.
- Select the desired language by pressing **+** buttons and confirm it by pressing **OK**. (Remark: By pressing **M** you move one step backwards from the current position)
- If required, date, time and daylight savings time mode can be adjusted also by pressing **+** buttons and a subsequent confirmation with **OK**.
- When using the astro function it is obligatory to enter the geographical position of the place of the installation of the device. Choose with **+** buttons between „Zone“ (predefined zip codes) and „Coordinates“ (longitude and latitude). Confirm your choice again with **OK**. (The easiest way is choosing a predefined zip code within the „Zone“-menu.)
- Enter the nearest zip code or the geographical coordinates with **+** buttons and confirm with **OK**.
- Finally, you can activate the Astro-program for the whole week (no offset) by confirming „Astro preprogrammed“! If you choose „Astro not preprogrammed“ you can individually program the Astro-function later in the programming menu. To complete the initial operations confirm your choice with the **OK** button.

**3. Technical data**

Supply voltage 230 V, 50-60 Hz  
 Power consumption 0,2-1,0W (depending on the switching status)  
 Contact material AgSnO2  
 Type of protection IP 20 to DIN EN 60529  
 Permitted ambient temperature -30°...+55°  
 Mode of operation 1 BSTU  
 Degree of contamination 2  
 Rated surge voltage 4 kV  
 Standard DIN EN 60730-1/DIN EN 60730-2-7  
 CFL, LED  
 Ideal for modern lamps

**4. Service**

Sangamo Limited  
 Industrial Estate, Port Glasgow,  
 Renfrewshire, PA14 5XG  
 Tel: 01475 745131 Fax: 01475 600370  
 Email: enquiries@sangamo.co.uk  
 Web: www.sangamo.co.uk



**5. Intended use**

DIN-rail mounting product.  
 The device fits for the particular use of the following tasks:  
 Illumination of private and industrial areas, street and shop-window lightening, regulation of air conditioning, flushing, motors, pumps, plants and machinery as well as to simulate presence etc.  
 Operate the device in a dry room only! The installation must be in accordance with the instruction manual. The device is not qualified for security relevant tasks such as emergency doors, fire protection equipment

**6. Battery**

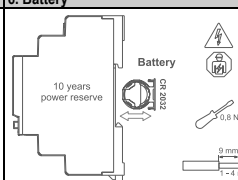

10 years power reserve

**7. Permanent**

Permanent ON / OFF

24.12. - 26.12.  
 08:00 - 12:00

Per Off A

**8. Key function**

**M** 1. To access the Enter-mode from the automatic-mode.  
 2. To revert to the beginning of the current (sub-) menu.

**+** 1. To adjust the flashing digit.  
 2. To scroll through a choice

**A B** 1. Automatic-mode: To switch the channel ON or OFF until the next programming step occurs.  
 2. Automatic-mode: A push longer than 3 sec. = Permanent switching status.

**OK/M** 1. To activate the time switch when operated without power supply.  
 2. To confirm the selection or the entered data.

**9. Handling advice**

- The time switch is programmable without external power supply after pressing the **OK** / **M**-button.
- To revert one step or one level back while in the Enter-Mode press **M**.
- After completion of a (sub-) menu confirming end will return the device into the automatic-mode.
- With **+** the choice changes from **end** to **continue**. By confirming **continue** the time switch returns to the beginning of the current (sub-) menu.
- When confirming end before completion, the time switch returns to the automatic-mode without saving the entered data.

**10. Additional adjustments**

Menu	Main menu	Application
Program query	Program	To query the programming steps and remaining memory locations
Program delete	Program	Deletion of switching time(s). The program for all channels, single channels and single programming steps within on channel can be deleted.
Date-Time	Adjustment	Adjustment of date and time
Summertime	Adjustment	Adjustment of the daylight saving time mode (ON/OFF)
Language	Adjustment	Choice of languages
Factory Defaults	Adjustment	Reset to the state of delivery.
Counter	Options	Displays the hour counter and pulse counter for each channel and the time switch itself.
PIN-Code	Options	The time switch can be locked with a 4-digit PIN-Code. The code can be adjusted, activated and deactivated. If you have forgotten the Code please call customer service.

**11. Menu overview**

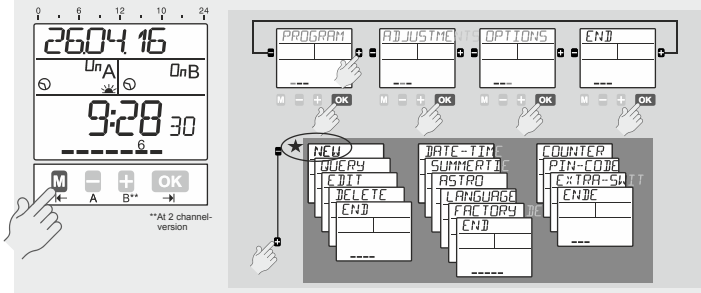

**12. Symbol legend**

- On** Channel is switched ON
- Off** Channel is switched OFF
- Perm** For the current date the "holiday program" / "permanent by date" is activated
- Standard** Standard programming step
- Manual** Current state is based on a manual over-ride. The state will be cancelled with the next programming step.
- Perm** Current state is based on a manual override. The state is permanent until terminated manual.
- 1234567** Days of the week Monday, Tuesday, ... Sunday; The underscores indicate if the program is active for the days above.
- Astro** Astro function: Current state is based on a sunrise or sunset taking into account an optionally adjusted Offset.
- Lock** The time switch is locked; to unlock the device the PIN has to be entered.

**13. New program**

**ASTROPROGRAM**

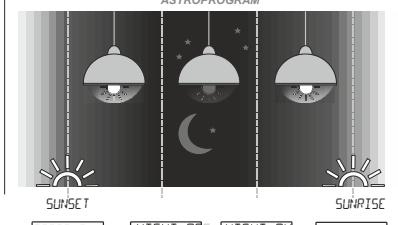

**EXTRAPROGRAM**

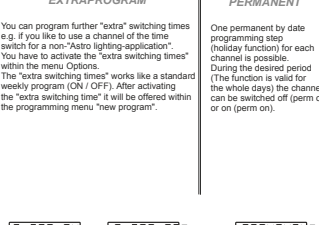

**PERMANENT**

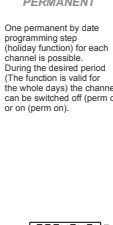

**14. Astro adjustment**

easy to find

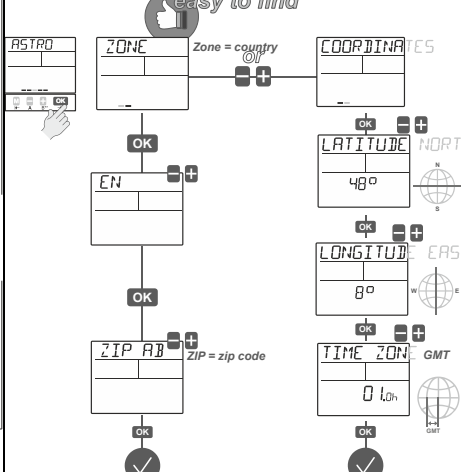

**15. Programming via NFC**

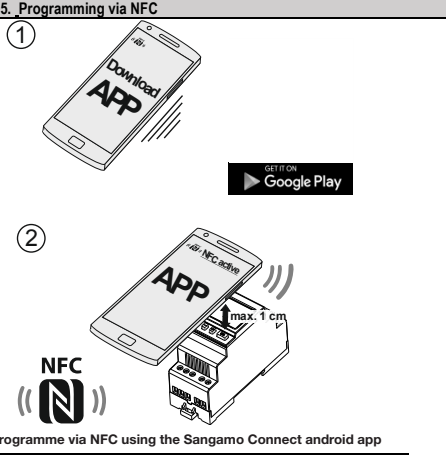

Programme via NFC using the Sangamo Connect android app

**16. Sangamo Limited**

Industrial Estate, Port Glasgow,  
 Renfrewshire, PA14 5XG  
 Tel: 01475 745131 Fax: 01475 600370  
 Email: enquiries@sangamo.co.uk  
 Web: www.sangamo.co.uk

