



Fire Control Panel **MAG2 / MAG4**



User Manual

Version 4

/Metal and plastic box/

**READ THIS MANUAL BEFORE CONNECTING THE
EQUIPMENT AND KEEP IT SAFE FOR FUTURE REFERENCE.**

To call our technical support line dial:

+44 (0) 1527 51 51 50

CE1293



WARNING

This manual contains information on limitations regarding product use and function and information on the limitations as to liability of the manufacturer.

The entire manual should be carefully read!

General Information

The system is to be installed by a qualified person to the latest Fire Alarm and Installation Regulations which are mandatory in the applicable country of installation. Before commencing the installation of this Fire Alarm Panel, ensure it is sited in a position, which is visible to the Fire Brigade when entering the premises, and where ease of access is provided for users and service engineers. Space must be available to easily open external and internal doors.

The Electrical Supply to the panel must be isolated and must not be capable of being accidentally switched off. A 'Lockable Switch fuse Unit' positioned within 2 meters of the panel should be clearly labelled FIRE ALARM - DO NOT SWITCH OFF.

EN 54-2 compatible panels.

All specifications are subject to change without notice.

Technical Support help:

+44 (0) 1527 51 51 50

CONTENTS

General Information	2
Guarantee	4
Using the MAG2 / MAG4 controls	5
Indicators / Outputs	5
Service Facilities	5
Installing the Panel	6
Testing the Panel	6
Engineers Facilities	8
Connecting the Additional Facilities	10
Specification	10
APPENDIX:	
Connection Circuit MAG2 / MAG4 metal box	11
Connection Circuit MAG2 / MAG4 plastic box	11
Fire Alarm Record	12
Service Record	12
Fire Alarm Event Log	13
Spare Parts Kit MAG2 / MAG4	14
Notes	15

GUARANTEE

During the guarantee period the manufacturer shall, at its sole discretion, replace or repair any defective product when it is returned to the factory. All parts replaced and/or repaired shall be covered for the remainder of the original guarantee, or for ninety (90) days, whichever period is longer. The original purchaser shall immediately send manufacturer a written notice of the defective parts or workmanship, which written notice must in all cases be received prior to expiry of the guarantee.

International Guarantee

Foreign customers shall enjoy the same guarantee rights as those enjoyed by any customer in Bulgaria, except that manufacturer shall not be liable for any related customs duties, taxes or VAT, which may be payable.

Guarantee Procedure

This guarantee will be granted when the appliance in question is returned. The manufacturer shall accept no product whatsoever, of which no prior notice has been received.

Conditions for waiving the guarantee

This guarantee shall apply to defects in products resulting only from improper materials or workmanship, related to its normal use. It shall not cover:

§ Damages resulting from improper transportation and handling;

§ Damages caused by natural calamities, such as fire, floods, storms, earthquakes or lightning;

§ Damages caused by incorrect voltage, accidental breakage or water; beyond the control of the manufacturer;

§ Damages caused by unauthorized system incorporation, changes, modifications or surrounding objects:

§ Damages caused by peripheral appliances (unless such peripheral appliances have been supplied by the manufacturer:

§ Defects caused by inappropriate surrounding of installed products;

§ Damages caused by failure to use the product for its normal purpose; Damages caused by improper maintenance;

§ Damages resulting from any other cause, bad maintenance or product misuse.

In the case of a reasonable number of unsuccessful attempts to repair the product, covered by this guarantee, the manufacturer's liability shall be limited to the replacement of the product as the sole compensation for breach of the guarantee. Under no circumstances shall the manufacturer be liable for any special, accidental or consequential damages, on the grounds of breach of guarantee, breach of agreement, negligence, or any other legal notion.

Waiver

This Guarantee shall contain the entire guarantee and shall be prevailing over any and all other guarantees, explicit or implicit (including any implicit guarantees on behalf of the dealer, or adaptability to specific purposes), and over any other responsibilities or liabilities on behalf of the manufacturer. The manufacturer does neither agree, nor empower, any person, acting on his own behalf, to modify or alter this Guarantee, nor to replace it with another guarantee, or another liability with regard to this product.

Unwarranted Services

The manufacturer shall repair or replace unwarranted products, which have been returned to its factory, at its sole discretion under the conditions below. The manufacturer shall accept no products for which no prior notice has been received.

The products, which the manufacturer deems repairable, will be repaired and returned. The manufacturer has prepared a price list and those products, which can be repaired, shall be paid for every repaired appliance.

The closest equivalent product, available at the time, shall replace the products manufacturer deems unrepairable. The current market price shall be charged for every replaced product.

Using the MAG2 / MAG4 Controls

- Refer to the instructions on the inside of the outer door.

Indications / Outputs

- NORMAL:**
- The **green** LED next to the 'power Supply 230V AC' will be illuminated.
- FIRE:**
- Two integrated **red** status FIRE LED's and a zone identification LED will flash together on receipt of a FIRE condition and become steady after the Silence Alarm button is pressed.
 - An internal buzzer will operate until silenced.
 - The external sounders will operate.
 - The FIRE relay will energize.
- FAULT:**
- A **yellow** General Fault LED will always illuminate together with an external or internal identification LED.
 - An internal buzzer will sound.
 - The FAULT relay will de-energize.

Faults are monitored as follows:

Indication	Fault description
○ 1 / ○ 2 / ○ 3 / ○ 4	Zone fault - open or short circuit. Detector head removed.
○ μ P	Processor break down.
○ Sounder 1	Sounder Circuit One fault - open or short circuit, reverse connected sounder, or bad sounder parameters.
○ Sounder 2	Sounder Circuit Two fault - open or short circuit, reverse connected sounder, or bad sounder parameters.
○ +24V DC Overload	Overload of "+24" VDC power supply.
○ +24V DC Failed	Absence of "+24" VDC power supply.
○ Battery Low	Low battery condition.
○ Battery Lost	Battery loss.
○ AC	Mains Supply loss.
○ Charger	Battery charger fault.
○ AUX	Auxiliary supply fault.
○ Earth	Short circuit to earth.



NOTE: Fault conditions will not be announced instantly. There will be a short delay which will vary from condition to condition. Faults when cleared will automatically reset at the panel.

Engineers Facilities:

MAG2 / MAG4 has the ability to select various facilities to assist the engineer during installation and testing of the system. These facilities include:

- Zone Test** - Individual zones can be tested and activated without the need to return to the panel to effect a RESET. This is done automatically by the panel.
- Isolate Sounders** - System can be tested without operating the Sounder circuits.
- Disable / Enable Zone** - Each zone can be disabled / enabled.

Installing the Panel

- Choose the best location for the panel position, with an ambient temperature between -5°C and 40°C, away from heating sources, environmental dust and potential water ingress.
 - Remove all packaging and inspect visually the panel for any damage.
 - Remove the outer cover, by unscrewing the screws by means of the special tool supplied in the kit (MAG2 / MAG4 in metal housing). Stow the cover in a safe position.
 - Inspect the internal PCB and make sure the internal components are firmly in place.
 - Remove the PCB from the metal / plastic box. Stow in a safe location.
 - Choose which cable entry points to knock out and carefully remove the knock-outs.
 - Drill the wall to suit the back box centre fixing position, plug and insert a fixing screw.
- Note:** *If you are installing MAG2 / MAG4 in plastic box use the template on the back side of the packaging box to drill the mounting holes on the wall.*
- Fix the metal / plastic housing into mounting position and insert fixing screws.
 - Tighten all the fixing screws.
 - Route the external cables onto the back box, make off connection glands etc., **DO NOT make any connections at this stage. ENTER THE MAINS CABLE THROUGH ITS OWN CABLE ENTRY POINT AND KEEP MAINS WIRING AWAY FROM SYSTEM AND OTHER LOW VOLTAGE WIRING.**
 - Re-fit the PCB to the metal / plastic box.
 - Connect the mains supply and earth to the main terminal block. **DO NOT** switch on the main electrical supply at this stage.
 - Position the battery in an upright position.

Testing the Panel



ATTENTION: It has been assumed that prior to making the connection at the panel, the integrity of the system ALL wiring has been comprehensively tested, including insulation to earth.

- Connect the battery leads from the black power supply box to the positive and negative battery terminals.
- Switch on the mains power supply.
- If the buzzer and indicator LED's are operating, press the RESET button.

In Normal Operating Mode only POWER SUPPLY 230V will be illuminated.

If in the Normal Operating Mode other LED's are illuminated and the buzzer is sounding, carefully check all fuses and connections. Refer to the page 7 for the associated yellow LED's apply to. The connection diagram on the inside of the external cover will assist in identifying the LED.



NOTE: The battery might show a 'Low Battery Fault' initially until it has had time to charge up to the required level.

ATTENTION: Do not short out the battery terminals because an internal protection will switch on and the panel will stop function!

If by some chance the fault will not cancel, and only on the advice of our Technical Support Department, **return the PCB CHASSIS ONLY to your supplier. DO NOT return the metal / plastic box.**

Once the panel is found to operate satisfactorily in the NORMAL MODE, it is time to connect the external circuits.

- Disconnect the mains power supply and the battery connection.
- Remove the EOL-module from the zone 1 terminal on the main module and fit it to the last detector of the zone 1 circuit as observe the polarity.
- Ensure all terminations are made correctly and all detector heads are plugged into their bases.
- Connect Detector circuit ONE to the panel terminal block.
- Power up the panel with the mains and battery.
- Press RESET button.

The panel should be in the 'NORMAL MODE'.



NOTE: If General Fault and zone 1 FAULT LED's illuminate, there is a wiring/ connection problem. Check the polarity of the connection, the connection of the devices and whether a head is removed.
Check the EOL proper polarity and position.

- Operate ALL detection devices applicable to this zone, to ensure correct receipt of a fire signal and the correct operation of the panel controls. Refer to the User Instructions on the inside of the panel.
- Repeat the connection process for the other zones stated above. ENSURE the supply voltages are initially disconnected prior to each stage.

ONCE THE CONNECTION OF THE ZONES ARE COMPLETED, CONNECT AND TEST ANY OF THE OTHER AUXILIARY CIRCUITS BEFORE CONNECTING THE EXTERNAL SOUNDER CIRCUITS.

Relay Connection - The on board relay volt free change over terminals are for low voltage use only.

MAINS SUPPLY MUST NOT BE APPLIED TO THESE TERMINALS.

Once the zone and auxiliary circuits have been connected and tested to function correctly, it is time to connect the first external sounder circuit:

- Disconnect the mains power supply and the battery connection.
- Remove the EOL-Resistor from the terminal block of sounder circuit 1 (SND 1) and fit to the last sounder of circuit one.
- Check all sounder connections are made.
- Connect sounder circuit ONE to the panel terminal block.
- Apply mains and battery power.
- Press RESET.

The panel should be in the 'NORMAL MODE'.

Activate a zone Call Point. The sounders should operate. Press the RESET button. Repeat the connection process for the second external sounder circuit, as stated above. ENSURE the supply voltages are initially disconnected prior to each stage.



NOTE: If General Fault and SOUNDER FAULT / DISABLE LED's illuminate, there is a wiring / connection problem. Check the polarity of the connection of each of the devices, the polarity of the connection of the devices to the Panel terminal block or whether an earth fault exists.

Engineers Facilities

Buttons Functions

Button	Description
SOUND ALARM	Activating sounders.
SILENCE ALARM	Deactivating sounders.
SILENCE BUZZER	Deactivating the internal buzzer.
ENABLE / DISABLE	Enabling / Disabling of Zones / Sounders.
TEST / SCROLL	Test mode; Scroll forward zones.
RESET	Initialization; Confirm the introduced changes.

ON / OFF - Switch for changing over between Access Levels 1 and 2:

- **OFF position** (Access Level 1) - only the **SILENCE BUZZER** button is active;
- **ON position** (Access Level 2) - all buttons at the front panel are active.

To Disable Zone 1:

Press ENABLE / DISABLE button: *Zone 1 LED will flash.
DISABLE / ENABLE LED will flash.*

Press ENABLE / DISABLE button: *The zone LED will become steady.*

Press RESET: ***At this point the zone 1 is disabled.***

To Enable Zone 1:

Press ENABLE / DISABLE button TWICE: *Zone 1 LED will flash.
DISABLE / ENABLE LED will flash.*

Press RESET: ***At this point the zone 1 is enabled.***

To Disable Zone 2:

Press ENABLE / DISABLE button: *Zone 1 LED will flash.
ENABLE / DISABLE LED will flash.*

Press TEST / SCROLL button: *Zone 2 LED will flash.
ENABLE / DISABLE LED will flash.*

Press ENABLE / DISABLE button: *Zone 2 LED will become steady.
ENABLE / DISABLE LED will flash.*

Press RESET: ***At this point the zone 2 is disabled.***

To Enable Zone 2:

Press ENABLE / DISABLE button: *Zone 1 LED will flash.
ENABLE / DISABLE LED will flash.*

Press TEST / SCROLL button: *Zone 2 LED will be steady.
ENABLE / DISABLE LED will flash.*

Press ENABLE / DISABLE button: *Zone 2 LED will flash.
ENABLE / DISABLE LED will flash.*

Press RESET: ***At this point zone 2 is enabled.***

Enabling and disabling of zones 3 and 4 is done in the same way as pressing TEST/ SCROLL button till reaching the desired zone and choosing consequently buttons DISABLE / ENABLE and RESET.

To ‘One Man’ Test a Zone:

Press TEST / SCROLL button: *TEST AND ZONE yellow LED’s will flash.
Zone 1 is in Test Mode.*

Press TEST / SCROLL button: *Flashing LED will move down to zone 2.
Zone 2 is in Test Mode.*

Continue the “One Man” Test for zones 3 and 4 by pressing TEST / SCROLL button. You will leave automatically the Test Mode when reaching the last zone, or at any time, by pressing RESET.

To disable Sounders:

Press DISABLE / ENABLE button: *DISABLE / ENABLE LED will flash.
Zone 1 LED will flash.*

Press TEST / SCROLL button: *Zone 2 LED will flash.*

Press TEST / SCROLL button
3 times again: *SOUNDER FAULT / DISABLE LED will flash.
DISABLE / ENABLE LED will flash.*

Press ENABLE / DISABLE button: *SOUNDER FAULT / DISABLE LED changes to
steady.
ENABLE / DISABLE LED flashes.*

Press RESET: ***At this point zone the sounders are disabled.***

To enable Sounders:

Press DISABLE / ENABLE button: *DISABLE / ENABLE LED will flash
Zone 1 LED will flash.*

Press TEST / SCROLL button: *Zone 2 LED will flash.*

Press TEST / SCROLL button
3 times again: *SOUNDER FAULT / DISABLE LED will be
steady.
DISABLE / ENABLE LED will flash.*

Press ENABLE / DISABLE button: *SOUNDER FAULT / DISABLE LED change to
flashing.
ENABLE / DISABLE LED flashes.*

Press RESET: ***At this point zone the panel has reset.***

Connecting The Additional Facilities

Class Change:

Connect a 'non latching' switch to the class change terminals at the top of the MAIN BOARD.

Operation of the switch will cause the external sounders to pulse one second on followed by one second off.

Once the panel connections and facilities have been functionally tested, replace and secure the front cover of the box, remembering to connect the earth bonding lead to the continuity terminal.



NOTE: The final closing of MAG2 / MAG4 plastic box is by placing the two nuts in the holders on the back side of the box cover. Then you have to fix the two screws M3x15 from the set.

The final closing of MAG2 / MAG4 metal box is by fixing the two secure bolts on the front side of the pane by using the given special tool in the set.

Specification MAG2 / MAG4

Maximum number of detectors per zone	Up to 20 conventional detectors and unlimited number of manual call points.
Thresholds for zone conditions	
• 0 - 2 mA	Open circuit fault condition.
• 2 - 6 mA	Normal condition.
• 6 - 110 mA	Fire Alarm condition.
• 110 mA - Short circuit	Short circuit condition.
Power Supply	
Main Power supply	230V AC $\pm 10\%$, 0.315A fuse
Standby Power supply	1 x 12V / 7Ah , 2A fuse
Maximum current available for system devices (with fully charged battery)	0.7 A
Current consumption - mains failure	50 mA
Outputs	
Sounder Circuit 1	24V / 0.3A, 0.3A fuse (PTC)
Sounder Circuit 2	24V / 0.3A, 0.3A fuse (PTC)
Fault Relay, volt free changeover contacts*	3A @ 120V AC, 3A @ 60V DC
Fire Relay, volt free changeover contacts*	3A @ 120V AC, 3A @ 60V DC
* Note: These functions may not be used to provide any "Options with requirements" as specified in EN 54-2.	
Auxiliary output	24V DC, 0.3A fuse (PTC)
Cabling	Maximum 2.5mm diameter
Environment	
Working temperature	-5 to +40°C
Storage temperature	-20 to +60°C
Humidity	0 to 95%

Connection circuit MAG2 / MAG4 metal box

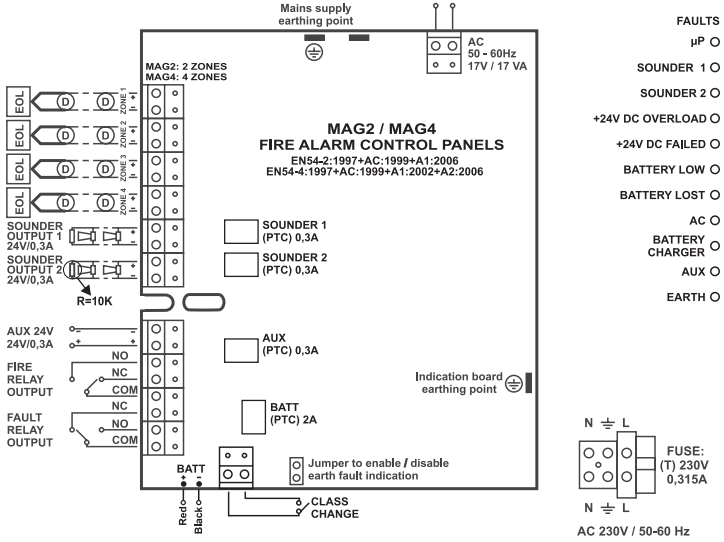

Connection circuit MAG2 / MAG4 plastic box

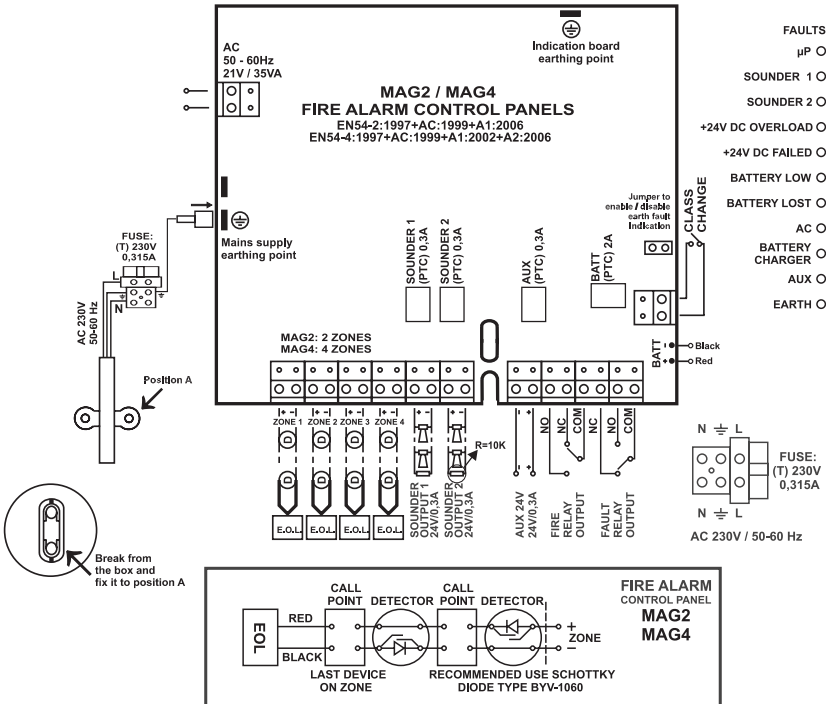

Fire Alarm Record

Installation Address:

.....

.....

.....

Contact Person:

Telephone:

Fax:

Date Completed:

Commissioned By:

Contract Reference:

Service Intervals: Monthly / Quarterly / Half Yearly / Annually

ZONE No	LOCATION	DETECTOR TYPE and QUANTITY PER ZONE					SOUNDERS (Zone Quantity and Related Circuit)	
		Ion*	Ph	RoR	F/T	CP	Circuit1	Circuit2
1								
2								
3								
4								
	TOTALS:							

* **Ion** - Ionisation sensor, **Ph** - Photoelectric sensor, **RoR** - Rate of Rise sensor, **F/T** - Fixed Temperature sensor, **CP** - Call Point

System Installed By:

Telephone / Fax:







Service Record







Date Visit Completed	Zones Tested	Faults Rectified	Signature of Engineer	Next Due
	1 2 3 4		Name:	
	1 2 3 4		Name:	
	1 2 3 4		Name:	
	1 2 3 4		Name:	

Fire Alarm Event Log

DATE	TIME	FIRE yes / no	ZONE number	FAULT yes/no and TYPE	ACTION TAKEN	Name

Spare Parts Kit

Metal Box			
No	Component	Description	Quantity MAG2 / MAG4
1		Fuse 0.315A, 5x20	1
2		Keys, 10mm	2
3		Cable tie, 2.5/100mm	1
4		Rubber cap, 20mm	1
5		EOL Module	1
6		10k ±1% 0.25W	1

Plastic Box			
No	Component	Description	Quantity MAG2 / MAG4
1		Fuse 0.315A, 5x20	1
2		Keys, 10mm	2
3		Self-tapping screw, 2,9x13 crossed slot DIN 7981	2
4		Plastic cap, 20mm	4
5		EOL Module	1
6		10k ±1% 0.25W	1

Elite Security Products Ltd

*Unit 7 Target Park,
Shawbank Road, Lakeside,
Redditch B98 8YN
UK*

Tel.: 01527 51 51 50

Fax: 01527 51 51 43

Distributed by: